



FLUIDO 70

PARTIZIONI E PORTE IN VETRO

Partitions and glass doors - Divisorias y puertas de vidrio
Glastrennwände und -türen - Divisions et porte en verre



FLUIDO 70

SISTEMA SCORREVOLE COMPATTO

COMPACT SLIDING SYSTEM



Fluido 70 é un sistema per porte scorrevoli in vetro che unisce tecnologia ad un design minimale. Si installa facilmente e rapidamente adattandosi a qualsiasi ambiente residenziale e/o commerciale.

Fluido 70, applicabile ad ante in vetro di 8-10 mm di spessore e con un peso massimo di 70kg per pannello, nasconde il suo meccanismo all'interno del binario superiore garantendo una linea compatta ed essenziale.

Questo scorrevole permette inoltre di scegliere un sistema frenante anti shock o Softclose assicurando cosí uno scorrimento leggero, lento e sicuro evitando forti impatti. Il sistema doppio Softclose assicura questo tipo di frenata su entrambi i lati e può essere installato su ante di soli 635 mm di larghezza.

Fluido 70 può essere installato a soffitto, a parete e falso soffitto. Per installazioni a parete, la caratteristica piú importante é rappresentata dalla distanza tra parete e pannello che può essere compresa tra 16 mm e 24 mm, a seconda delle necessità.

Il sistema viene offerto in due finiture: alluminio naturale e simil inox satinato.

Fluido 70 is a system for glass sliding doors which combines technology and minimal design. It can be easily and quickly installed, and it fits every commercial or residential environment.

Fluido 70 fits glass panels 8-10 mm thick, with a maximum weight of 70 kg per panel, hides the mechanism within the rail, giving a compact and essential shape.

This sliding system allows to choose an antishock or Softclose as well, ensuring thus a smooth, slow and safe movement which avoids hits. The double Softclose system guarantees this kind of braking on both sides of the panel, whose minimum width is just 635 mm.

Fluido 70 can be installed on ceiling, wall or false ceiling. For wall applications, the most important feature is the distance between wall and panel, which can vary from 16 to 24 mm depending on needs.

The system is available in two finishes: natural aluminum and imitation satin stainless steel.

+ info saheco.com



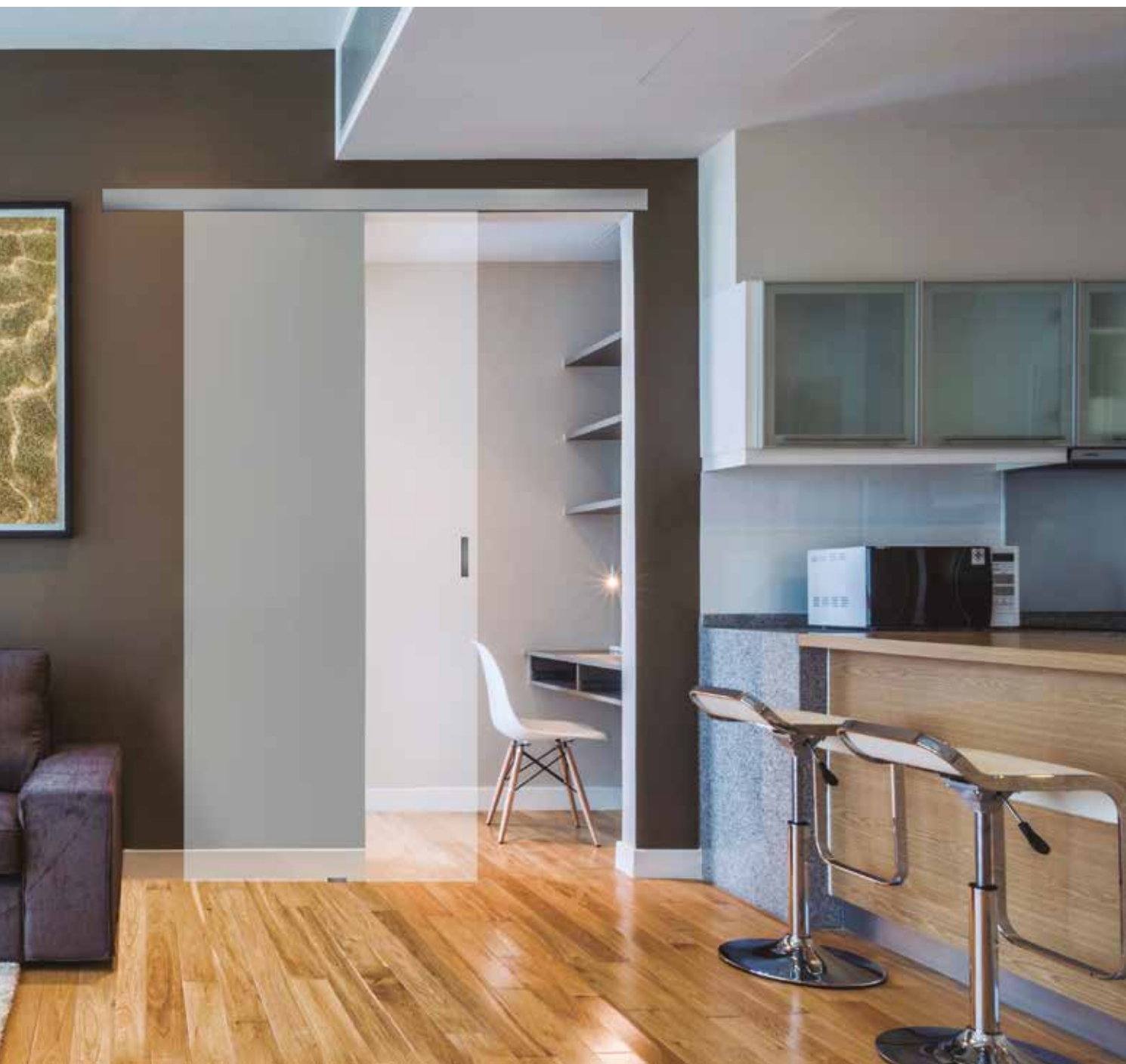

Proyecto: Rodríguez +Pintos Arquitectos
Fotografía: Héctor Santos-Díez

VERSATILE

PRATICO E SEMPLICE

HANDY AND
SIMPLE



MINIMALISTA MINIMALIST



SICURO E FLUIDO

SECURE
& FLUID



COMPATTO COMPACT

Fluido 70 è il sistema compatto ed essenziale in cui tutti gli accessori sono nascosti all'interno della guida, garantendo così un design minimale.

Fluido 70 is the compact and essential system where all accessories are within the rail, giving a minimal design.

MINIMALE ED ELEGANTE MINIMAL AND ELEGANT

Le contenute dimensioni del sistema permettono di ridurre al minimo la distanza tra vetro e parete, e tra vetro scorrevole e fisso.

The dimensions of the system allow to reduce at its minimum the distance between wall and panel, and between sliding and fixed panel.

VERSATILE VERSATILE

Un sistema adattabile a qualsiasi tipo di necessità grazie alle diverse opzioni di montaggio a soffitto, a parete e a falso soffitto. Anche con vetro fisso. Disponibile in diverse finiture. Possibilità di Softclose o Antishock.

Fluido 70 adapts to every need due to the different possibilities in application: wall, ceiling or false ceiling fixing. It can fit a fixed panel as well. Available in different finishes. Chance of using Softclose or Antishock.



ELEGANTE
ELEGANT



COMPATTO
COMPACT

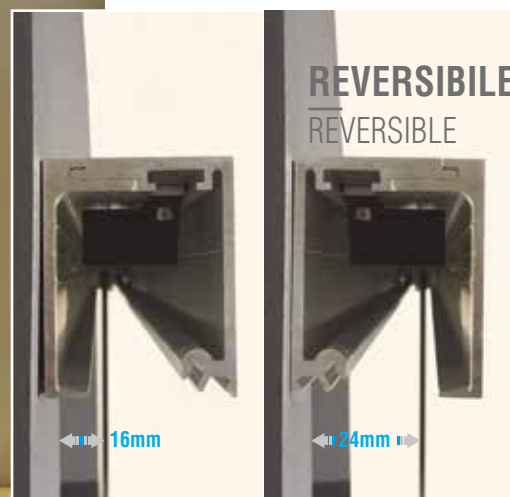

REVERSIBILE
REVERSIBLE

16mm

24mm

REVERSIBILE
REVERSIBLE

Si può installare a parete su entrambi i lati seguendo i punti guida di foratura. Questa caratteristica, unica nel mondo degli scorrevoli, permette di scegliere la distanza del vetro a parete a seconda delle necessità.

It Can be installed on wall on both sides by following guide fixing holes. This feature, unique in the sliding systems' world, allows to choose the distance between glass and wall according to the different needs.

SICURO E FLUIDO
SECURE AND FLUID

Grazie alla tecnologia Softclose, il sistema permette di chiudere e aprire la porta dolcemente evitando contraccolpi negli ultimi centimetri. La sicurezza è garantita.

Thanks to Softclose technology, the system allows a smooth movement in opening and closing, avoiding recoils during the last centimetres. Security is guaranteed.

PRATICO E SEMPLICE
HANDY AND SIMPLE

FLUIDO 70 si installa facilmente e rapidamente in qualsiasi ambiente residenziale e/o commerciale. I profili sono dotati di preforature che consentono un rapido posaggio.

Fluido 70 is easily and quickly installed in every commercial and residential environment. The profiles are pre-drilled which allow a rapid installation.

CARATTERISTICHE TECNICHE

TECHNICAL CHARACTERISTICS

Profili Profiles

Scorrevole Sliding
(fissaggio a parete - wall mounting)



48 x 60 mm



48 x 60 mm

(fissaggio a soffitto - ceiling mounting)



48 x 60 mm

Scorrevole Sliding
(fissaggio a vetro fisso - sidelight mounting)



48 x 60 mm

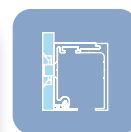

48 x 60 mm

Scorrevole con vetro fisso
Sliding with sidelight
(fissaggio a soffitto - ceiling mounting)



48 x 70 mm

Scorrevole a falso soffitto
Sliding false ceiling















76 x 61 mm

Scorrevole con vetro fisso a falso soffitto
Sliding with sidelight on false ceiling



76 x 61 mm

Dettagli tecnici Technical details

 PORTATA Weight	70kg per pannello / for door	
 SPESORE VETRO Glass thickness	8 - 10 mm	
 REGOLAZIONE IN ALTEZZA Height adjustment	3 mm	
 REVERSIBILITÀ Reversibility	✓	
 DISTANZA A PARETE Wall distance	vetro glass 8 mm 16 / 24 mm	vetro glass 10 mm 14 / 24 mm
 DISTANZA TRA ANTA E VETRO FISSO Distance between door and sidelight	vetro glass 8 mm 12 mm	vetro glass 10 mm 10 mm
 INSTALLAZIONE A VETRO Glass installation	✓	
 INSTALLAZIONE A FALSO SOFFITTO False ceiling installation	✓	
 INSTALLAZIONE TRA PARETI Installation between walls	✓	
 SOFTCLOSE Soft close	Singolo e Doppio / Single and Double	
 DIMENSIONI MINIME (doppio Softclose) Minimum dimensions (double soft close)	635 mm	
 ANTISHOCK Antishock	Singolo e Doppio / Single and Double	
 DIMENSIONI MINIME (doppio Antishock) Minimum dimensions (double antishock)	450 mm	
 FINITURE Finishes	Alluminio naturale Aluminum	Simil inox Imitation Satin Stainless Steel
 CERTIFICAZIONE DURABILITÀ CICLI CORROSIONE Durability certification Corrosion cycles	EN1527/EN1670 6 100.000 3 (96h)	

Possibilità di installazione Installation Alternatives

SCORREVOLE A SOFFITTO Sliding on Ceiling

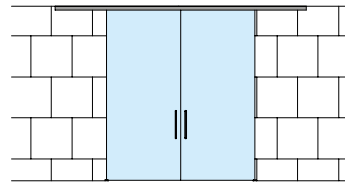
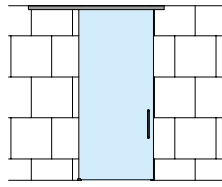
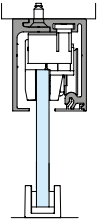

SCORREVOLE A PARETE Sliding on Wall

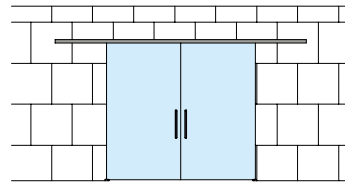
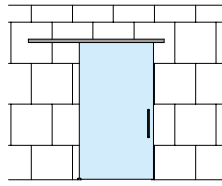
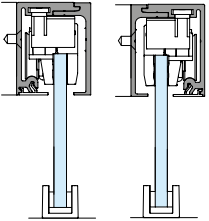

SCORREVOLE SU VETRO FISSO Sliding on Sidelight

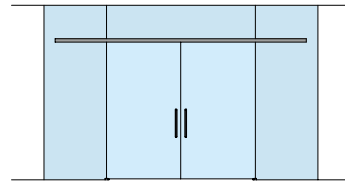
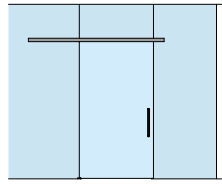
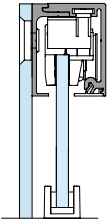

SCORREVOLE A SOFFITTO CON FISSO Sliding on Ceiling with Sidelight

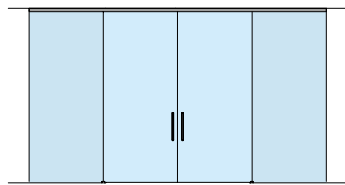
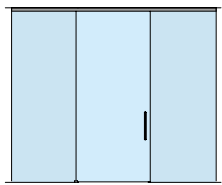
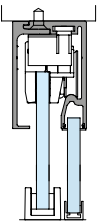

SCORREVOLE A FALSO SOFFITTO Sliding on False Ceiling

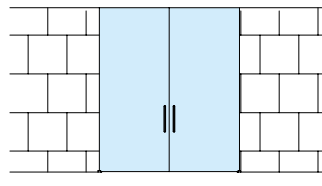
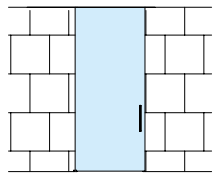
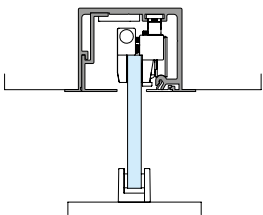

SCORREVOLE A FALSO SOFFITTO CON FISSO Sliding on False Ceiling with Sidelight

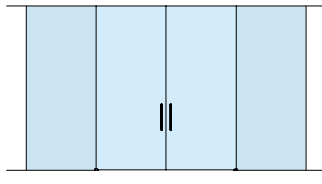
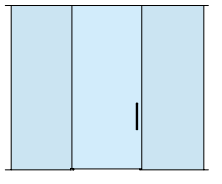
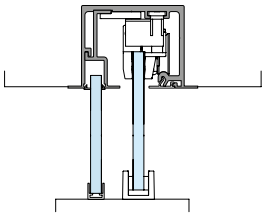

INSTALLAZIONE CON SUPPORTI A PARETE Installation with Supports on Wall

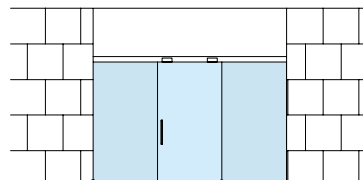
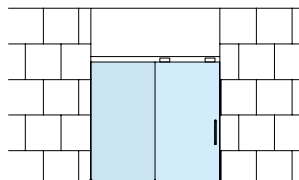
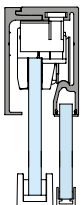

CONFIGURAZIONI

Configurations

SCORREVOLE A PARETE / SOFFITTO Sliding on Wall / Ceiling

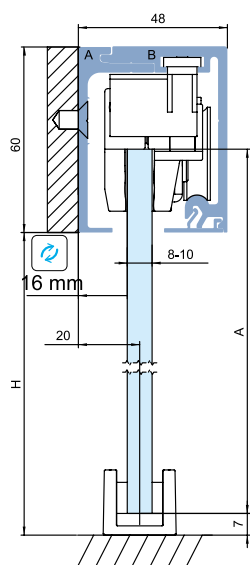

$$A = H + 20\text{mm}$$

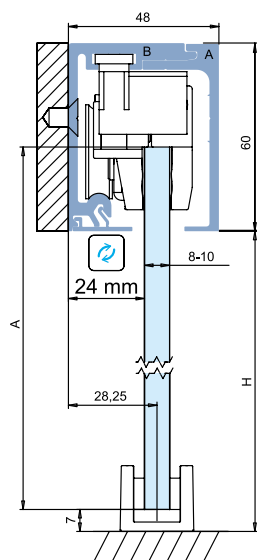

$$A = H + 20\text{mm}$$

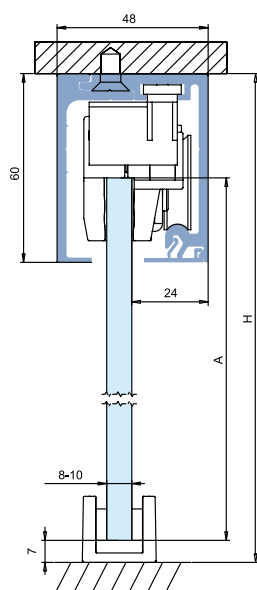

$$A = H - 40\text{mm}$$

PORTA SINGOLA Single Door

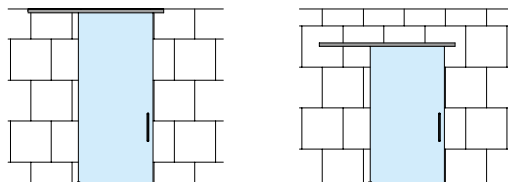

KIT COMPRENDE:
1 x binario + 1 x kit pinze +
2 x tappo + 1 x guida a terra
 1 x rail + 1 x kit pliers +
 2 x cap + 1 x floor guide

1KB70W K1NN
 2 x Freno/Brake standard

1KB70W K1AS
 1 x a Anti Shock +
 1 x Softclose

1KB70W K1SS
 2 x Softclose

FINITURA 02 alluminio naturale natural aluminum	2 m	2 m	2 m
	2,5 m	2,5 m	2,5 m
	3 m	3 m	3 m
FINITURA 13 simil inox imitation satin stainless steel	5 m	5 m	5 m
	2 m	2 m	2 m
	2,5 m	2,5 m	2,5 m
	3 m	3 m	3 m
	5 m	5 m	5 m

PORTA DOPPIA Double Door

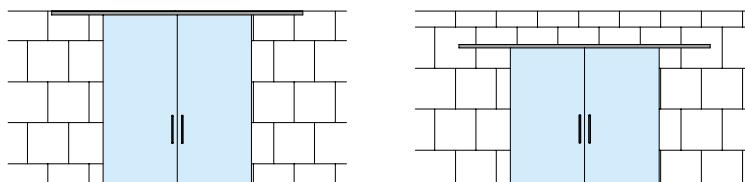

KIT COMPRENDE:
1 x binario + 2 x kit pinze +
2 x tappo + 2 x guida a terra
 1 x rail + 2 x kit pliers +
 2 x cap + 2 x floor guide

2KB70W K1NN
 4 x Freno/Brake standard

2KB70W K1AS
 2 x Anti Shock +
 2 x Softclose

2KB70W K1SS
 4 x Softclose

FINITURA 02 alluminio naturale natural aluminum	2 m	2 m	2 m
	2,5 m	2,5 m	2,5 m
	3 m	3 m	3 m
FINITURA 13 simil inox imitation satin stainless steel	5 m	5 m	5 m
	2 m	2 m	2 m
	2,5 m	2,5 m	2,5 m
	3 m	3 m	3 m
	5 m	5 m	5 m

SCORREVOLE A SOFFITTO CON FISSO Sliding on Ceiling with Sidelight



PORTA SINGOLA Single Door

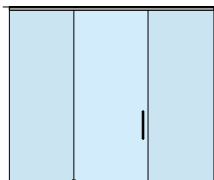

KIT COMPRENDE:
1 x binario + 1 x kit pinze +
2 x tappo + 1 x guida a terra
 1 x rail + 1 x kit pliers +
 2 x cap + 1 x floor guide

3KB70W K1NN
 2 x Freno/Brake standard

3KB70W K1AS
 1 x a Anti Shock +
 1 x Softclose

3KB70W K1SS
 2 x Softclose

FINITURA 02 alluminio naturale natural aluminum	2 m	2 m	2 m	2 m
	2,5 m	2,5 m	2,5 m	2,5 m
	3 m	3 m	3 m	3 m
FINITURA 13 simil inox imitation satin stainless steel	5 m	5 m	5 m	5 m
	2 m	2 m	2 m	2 m
	2,5 m	2,5 m	2,5 m	2,5 m
	3 m	3 m	3 m	3 m
	5 m	5 m	5 m	5 m

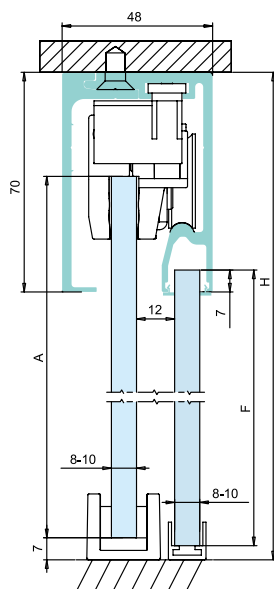

A= H - 40mm

F= H - 67mm

PORTA DOPPIA Double Door

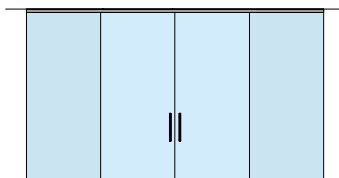

KIT COMPRENDE:
1 x binario + 2 x kit pinze +
2 x tappo + 2 x guida a terra
 1 x rail + 2 x kit pliers +
 2 x cap + 2 x floor guide

4KB70W K1NN
 4 x Freno/Brake standard

4KB70W K1AS
 2 x Anti Shock +
 2 x Softclose

4KB70W K1SS
 4 x Softclose

FINITURA 02 alluminio naturale natural aluminum	2 m	2 m	2 m
	2,5 m	2,5 m	2,5 m
	3 m	3 m	3 m
FINITURA 13 simil inox imitation satin stainless steel	5 m	5 m	5 m
	2 m	2 m	2 m
	2,5 m	2,5 m	2,5 m
	3 m	3 m	3 m
	5 m	5 m	5 m

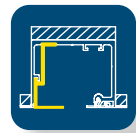

SCORREVOLE A FALSO SOFFITTO Sliding on False Ceiling

PORTA SINGOLA Single Door

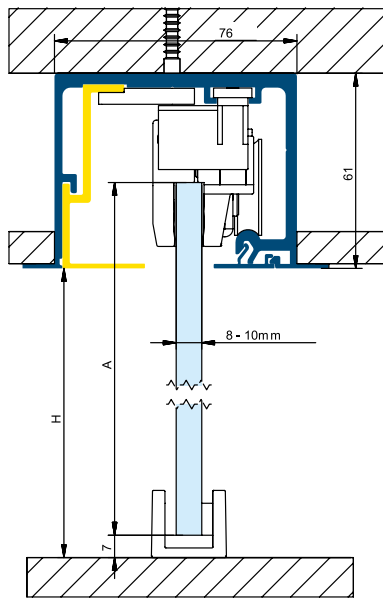
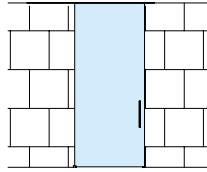

$$A = H + 20\text{mm}$$

KIT COMPRENDE: 1 x binario + 1 x kit pinze + 1 x guida a terra 1 x rail + 1 x kit pliers + 1 x floor guide	5KB70W K1NN 2 x Freno/Brake standard	5KB70W K1AS 1 x a Anti Shock + 1 x Softclose	5KB70W K1SS 2 x Softclose
FINITURA 02 alluminio naturale natural aluminum	2 m 3 m 4 m 6 m	2 m 3 m 4 m 6 m	2 m 3 m 4 m 6 m
FINITURA 13 simil inox imitation satin stainless steel	2 m 3 m 4 m 6 m	2 m 3 m 4 m 6 m	2 m 3 m 4 m 6 m

PORTA DOPPIA Double Door

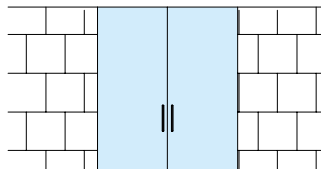

KIT COMPRENDE: 1 x binario + 2 x kit pinze + 2 x guida a terra 1 x rail + 2 x kit pliers + 2 x floor guide	6KB70W K1NN 4 x Freno/Brake standard	6KB70W K1AS 2 x Anti Shock + 2 x Softclose	6KB70W K1SS 4 x Softclose
FINITURA 02 alluminio naturale natural aluminum	2 m 3 m 4 m 6 m	2 m 3 m 4 m 6 m	2 m 3 m 4 m 6 m
FINITURA 13 simil inox imitation satin stainless steel	2 m 3 m 4 m 6 m	2 m 3 m 4 m 6 m	2 m 3 m 4 m 6 m

SCORREVOLE A FALSO SOFFITTO CON FISSO Sliding on False Ceiling with Sidelight



PORTA SINGOLA Single Door

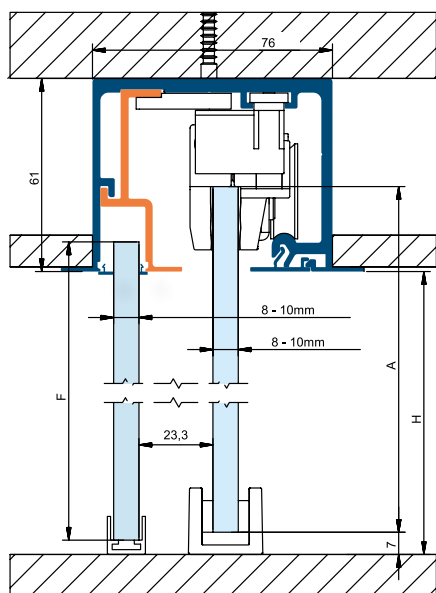
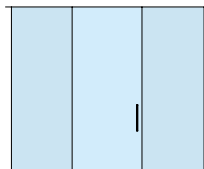

$$A = H + 20\text{mm}$$

$$F = H + 3\text{mm}$$

KIT COMPRENDE: 1 x binario + 1 x kit pinze + 1 x guida a terra 1 x rail + 1 x kit pliers + 1 x floor guide	7KB70W K1NN	7KB70W K1AS	7KB70W K1SS
	2 x Freno/Brake standard	1 x a Anti Shock + 1 x Softclose	2 x Softclose
FINITURA 02 alluminio naturale natural aluminum	2 m	2 m	2 m
	3 m	3 m	3 m
	4 m	4 m	4 m
	6 m	6 m	6 m
FINITURA 13 simil inox imitation satin stainless steel	2 m	2 m	2 m
	3 m	3 m	3 m
	4 m	4 m	4 m
	6 m	6 m	6 m

PORTA DOPPIA Double Door

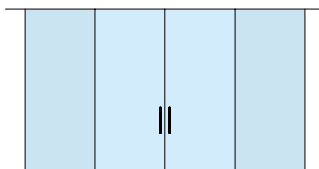

KIT COMPRENDE: 1 x binario + 2 x kit pinze + 2 x guida a terra 1 x rail + 2 x kit pliers + 2 x floor guide	8KB70W K1NN	8KB70W K1AS	8KB70W K1SS
	4 x Freno/Brake standard	2 x Anti Shock + 2 x Softclose	4 x Softclose
FINITURA 02 alluminio naturale natural aluminum	2 m	2 m	2 m
	3 m	3 m	3 m
	4 m	4 m	4 m
	6 m	6 m	6 m
FINITURA 13 simil inox imitation satin stainless steel	2 m	2 m	2 m
	3 m	3 m	3 m
	4 m	4 m	4 m
	6 m	6 m	6 m

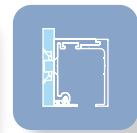
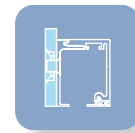

SCORREVOLE SU VETRO FISSO Sliding on Sidelight

PORTA SINGOLA Single Door

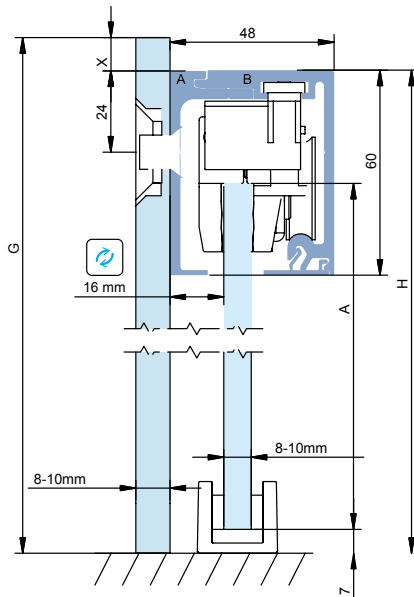
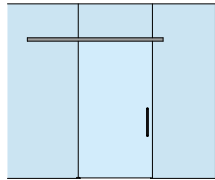

$$A = H - 40\text{mm}$$

$$G = H + X$$

KIT COMPRENDE:

**1 x binario + 1 x kit pinze +
2 x tappo + 1 x guida a terra**
1 x rail + 1 x kit pliers +
2 x cap + 1 x floor guide

9KB70W K1NN

2 x Freno/Brake standard

9KB70W K1AS

1 x a Anti Shock +
1 x Softclose

9KB70W K1SS

2 x Softclose

FINITURA 02 alluminio naturale natural aluminum	2 m 2,5 m 3 m 5 m	2 m 2,5 m 3 m 5 m	2 m 2,5 m 3 m 5 m
FINITURA 13 simil inox imitation satin stainless steel	2 m 2,5 m 3 m 5 m	2 m 2,5 m 3 m 5 m	2 m 2,5 m 3 m 5 m

NOTA: Aggiungere al prezzo del kit il prezzo delle borchie cod.B70WP7031
2mt = 10 borchie / 2,5mt = 12 borchie / 3mt = 15 borchie / 5mt = 25 borchie

PORTA DOPPIA Double Door

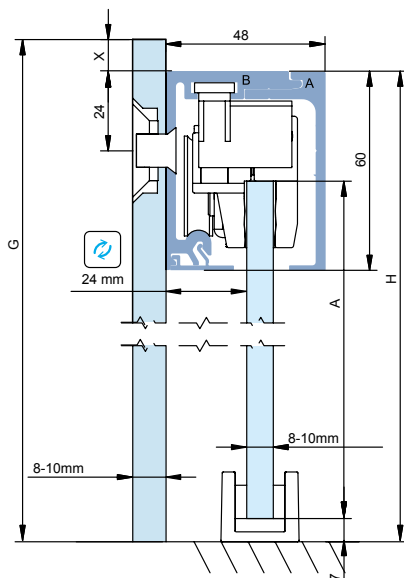
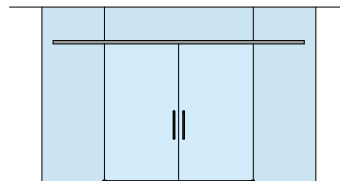

$$A = H - 40\text{mm}$$

$$G = H + X$$

KIT COMPRENDE:

**1 x binario + 2 x kit pinze +
2 x tappo + 2 x guida a terra**
1 x rail + 2 x kit pliers +
2 x cap + 2 x floor guide

10KB70W K1NN

4 x Freno/Brake standard

10KB70W K1AS

2 x Anti Shock +
2 x Softclose

10KB70W K1SS

4 x Softclose

FINITURA 02 alluminio naturale natural aluminum	2 m 2,5 m 3 m 5 m	2 m 2,5 m 3 m 5 m	2 m 2,5 m 3 m 5 m
FINITURA 13 simil inox imitation satin stainless steel	2 m 2,5 m 3 m 5 m	2 m 2,5 m 3 m 5 m	2 m 2,5 m 3 m 5 m

NOTA: Aggiungere al prezzo del kit il prezzo delle borchie cod.B70WP7031
2mt = 10 borchie / 2,5mt = 12 borchie / 3mt = 15 borchie / 5mt = 25 borchie

INSTALLAZIONE CON SUPPORTI A PARETE Installation with Supports on Wall



PORTA SINGOLA Single Door

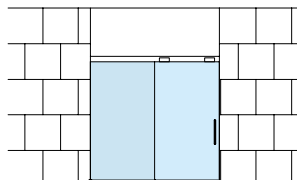

KIT COMPRENDE:

**1 x binario + 1 x kit pinze +
2 x attacchi laterali + 1 x guida a terra**
1 x rail + 1 x kit pliers +
2 x side attacks + 1 x floor guide

11KB70W K1NN
2 x Freno/Brake standard

11KB70W K1AS
1 x a Anti Shock +
1 x Softclose

11KB70W K1SS
2 x Softclose

FINITURA 02 alluminio naturale natural aluminum	2 m 2,5 m 3 m 5 m	2 m 2,5 m 3 m 5 m	2 m 2,5 m 3 m 5 m
FINITURA 13 simil inox imitation satin stainless steel	2 m 2,5 m 3 m 5 m	2 m 2,5 m 3 m 5 m	2 m 2,5 m 3 m 5 m

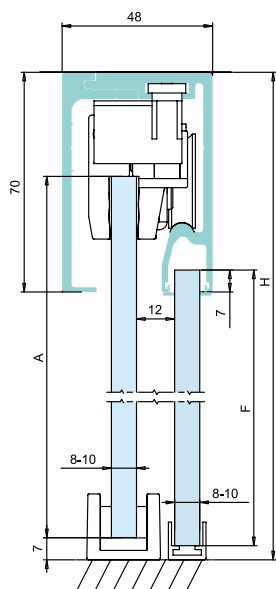

$$A = H - 40\text{mm}$$

$$F = H - 67\text{mm}$$

PORTA DOPPIA Double Door

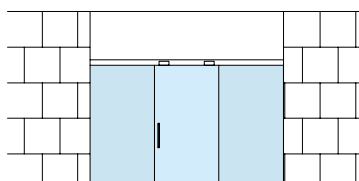

KIT COMPRENDE:

**1 x binario + 2 x kit pinze +
2 x attacchi laterali + 2 x guida a terra**
1 x rail + 2 x kit pliers +
2 x side attacks + 2 x floor guide

12KB70W K1NN
4 x Freno/Brake standard

12KB70W K1AS
2 x Anti Shock +
2 x Softclose

12KB70W K1SS
4 x Softclose

FINITURA 02 alluminio naturale natural aluminum	2 m 2,5 m 3 m 5 m	2 m 2,5 m 3 m 5 m	2 m 2,5 m 3 m 5 m
FINITURA 13 simil inox imitation satin stainless steel	2 m 2,5 m 3 m 5 m	2 m 2,5 m 3 m 5 m	2 m 2,5 m 3 m 5 m

COMPOSIZIONE KITS Kits Composition

SETS PROFILI

Sets Profiles

Cod. 

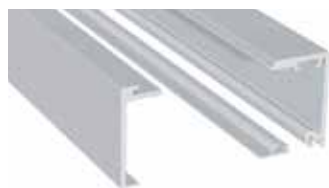

Set profili per installazione a parete / a soffitto

B70W K41/2 2 m
B70W K41/25 2,5 m
B70W K41/3 3 m
B70W K41/5 5 m

Finitura
Finishes **02**

Finitura
Finishes **13**



Set profiles installed on wall / ceiling

SETS PROFILI CON VETRO FISSO

Sets Profiles with Sidelight

Cod. 



Set profili per installazione con vetro fisso

B70W K43/2 2 m
B70W K43/25 2,5 m
B70W K43/3 3 m
B70W K43/5 5 m

Finitura
Finishes **02**

Finitura
Finishes **13**

Set profiles installed on sidelight

SETS PROFILI FALSO SOFFITTO

Sets Profiles False Ceiling

Cod. 



Set profili per installazione falso soffitto

B110W K44/2 2 m
B110W K44/3 3 m
B110W K44/4 4 m
B110W K44/6 6 m

Finitura
Finishes **02**

Finitura
Finishes **13**

Set profiles installed on false ceiling

SETS PROFILI FALSO SOFFITTO CON VETRO FISSO

Sets Profiles False Ceiling with Sidelight

Cod. 



Set profili per installazione falso soffitto con vetro fisso

B110W K45/2 2 m
B110W K45/3 3 m
B110W K45/4 4 m
B110W K45/6 6 m

Finitura
Finishes **02**

Finitura
Finishes **13**

Set profiles installed on false ceiling with sidelight

SET ACCESSORI

Set of Accessories

Cod. 



Set tappi laterali per profili a soffitto o a parete in plastica
Set of side caps for ceiling profiles or plastic walls

B70W P61N

Finitura
Finishes **02**

Finitura
Finishes **13**

Set tappi laterali per profili con vetro fisso in plastica
Set of side caps for profiles with plastic sidelight

B70W P63N

Finitura
Finishes **02**

Finitura
Finishes **13**

ACCESSORI

Accessories

Cod. 



Guida inferiore per vetro 8-10mm
Bottom U-channel for 8-10 mm

B70W P50

Finitura
Finishes **02**

Finitura
Finishes **13**

Alluminio naturale

02

Simil Inox satinato

13

SET ACCESSORI

Set of Accessories

Cod.



CUSCINETTI
A SFERE

Set di accessori Softclose doppio
Set of accessories for double soft close

B70W K1SS

Finitura
Finishes **00**



CUSCINETTI
A SFERE

Set di accessori Softclose
+ Anti Shock
Set of accessories for soft close
+ anti shock

B70W K1AS

Finitura
Finishes **00**



CUSCINETTI
A SFERE

Set di accessori 2 Anti Shock
Set of accessories for 2 anti shocks

B70W K1AA

Finitura
Finishes **00**



CUSCINETTI
A SFERE

Set di accessori Fermo
meccanico + Anti Shock
Set of accessories for stop
+ anti shock

B70W K1NA

Finitura
Finishes **00**



CUSCINETTI
A SFERE

Set di accessori Softclose +
Fermo meccanico
Set of accessories for soft close
+ stop

B70W K1NS

Finitura
Finishes **00**



CUSCINETTI
A SFERE

Set di accessori
2 Fermi meccanici
Set of accessories
for 2 stops

B70W K1NN

Finitura
Finishes **00**

ACCESSORI

Accessories

Cod.



Supporto per fissaggio a parete
a vetro fisso
Support for wall mounting
with sidelight

B70W P7031

Finitura
Finishes **31**

SET ACCESSORI

Set of Accessories

Cod.



Set fissaggio a parete
Set wall mounting

B70W P90

Finitura
Finishes **02** **Finitura**
Finishes **13**

Cod.



Set fissaggio a parete
Set wall mounting

B70W P9100

Finitura
Finishes **00**

Alluminio naturale

02

Simil Inox satinato

13

ES

Fluido 70 DIVISORIAS Y PUERTAS DE VIDRIO SISTEMA CORREDERAS COMPACTO

Fluido 70 es un sistema para puertas de vidrio correderas que une tecnología y diseño minimalista. Se instala fácil y rápidamente adaptándose a cualquier ambiente residencial o comercial.

Fluido 70, aplicable para puertas de vidrio de 8-10 mm de espesor y peso máximo de 70kg por puerta, esconde su mecanismo en el interior de la guía superior garantizando una línea compacta y elegante.

Este sistema de puertas correderas permite escoger opcionalmente el frenado anti-shock o Soft-close asegurando de esta manera un recorrido suave y seguro evitando impactos con fuerza. El sistema de doble Soft-Close asegura este tipo de frenado en ambos lados y puede ser instalado en puertas de hasta 635mm de ancho.

Fluido 70 se puede instalar a techo, a pared y a falso techo. Para la instalación a pared, la característica más destacable es la mínima distancia de separación entre pared y vidrio, entre 16 mm y 24 mm, según cada necesidad. El sistema se suministra en dos acabados: aluminio natural y simil inox satinado.

COMPACTO

Fluido 70 es el sistema compacto y elegante en el cual todos los accesorios se esconden en el interior de la guía garantizando un diseño minimalista.

MINIMALISTA Y ELEGANTE

Las dimensiones reducidas del sistema permiten reducir al mínimo la distancia entre vidrio y pared, así como entre puerta y vidrio fijo en su caso.

VERSÁTIL

Un sistema adaptable a cualquier tipo de necesidad gracias a las diversas opciones de montaje, a techo, a pared y a falso techo. También con vidrio fijo. Disponible en diversos acabados. Softclose o Antishock opcionales.

REVERSIBLE

Se puede instalar entre paredes siguiendo los puntos de mecanizado. Esta característica, única en el mundo de las correderas, permite escoger la distancia del vidrio a la pared según necesidad.

SEGURIDAD Y FLUIDEZ

Gracias a la tecnología Softclose, el sistema permite cerrar y abrir la puerta suavemente evitando los impactos de los centímetros finales. La seguridad está garantizada.

PRÁTICO Y SIMPLE

Fluido 70 se instala fácil y rápidamente en cualquier ambiente residencial y/o comercial. Los perfiles ya vienen taladrados lo cual permite una rápida instalación.

FR

Fluido 70 LES DIVISIONS ET PORTE EN VERRE LE SYSTÈME COULISSANTE COMPACTE

Fluido 70 c'est un système pour porte coulissante en verre qui combine technologie et un dessin minimaliste. Avec une installation facile et rapide il permet s'adapter sous tous les ambients résidentiels et commerciales.

Le FLUIDO 70 est disponible pour portes en verre d'épaisseur de 8-10mm et avec un poids maximum de 70 kg par panneau, son mécanisme est occulté dans le rail supérieur assurant une ligne compacte et essentielle. Ce glissement vous permet également de choisir un système de freinage Anti Shock ou Softclose assurant ainsi un glissement sécurisé, lent et léger en évitant des forts impacts. Le double système Softclose assure ce type de freinage des deux côtés et peut être installé qu'en 635 mm de large.

Le FLUIDO 70 peut avoir une installation sur plafond, mur et faux plafond. Pour le montage mural, la caractéristique la plus importante est représentée par la distance entre le panneau de paroi et qui peut être comprise entre 16mm et 24mm en fonction de la nécessité de l'installation. Le système est proposé en deux finitions: Aluminium Naturel et Aluminium Anodisé Argent.

COMPACTE

Fluido 70 c'est un système compacte et essentiel dans la quelle tous les accessoires sont placés à l'intérieur du rail en donnant un dessin minimaliste.

MINIMALISTE ET ÉLEGANTE

La forme du système permet de réduire au minimum la distance entre le verre et le mur en installation de verre fixe au coulissant.

VERSATILE

Système adaptable à tous les types d'installation grâce à ses options de montage plafond, murale, faux-plafond, inclus avec verre fixe. Disponible en différentes finitions. Possibilité de Softclose et AntiShock.

REVERSIBLE

Il peut être installé sur les deux côtés suivant la marque en pointillés. Cette caractéristique, le seul dans le monde des systèmes coulissants, permet de choisir la distance entre le verre et le mur selon les nécessités.

SECURE ET FLUIDE

Grâce à la technologie Softclose, le système permet d'ouvrir et fermer la porte doucement et éviter le coup aux dernières centimètres. Sécurité et garantie.

PRATIQUE ET SIMPLE

Fluido 70 permet une installation rapide dans des ambients résidentiels et commerciaux. Les rails Pre-mécanisés permettent une installation rapide.

DE

Fluido 70 GLASTRENNWÄNDE UND -TÜREN KOMPAKTES SCHIEBETÜRSYSTEM

Fluido 70 ist ein Schiebetürsystem für Glastüren, das Technologie mit einem minimalistischem Design verbindet. Das System kann schnell und einfach montiert werden, und eignet sich sowohl für gewerbliche als auch private Räumlichkeiten.

Fluido 70 ist für vorgespanntes Glas mit einer Glasdicke von 8-10 mm geeignet und einem maximalen Gewicht von 70 kg pro Scheibe. Der Mechanismus ist durch die Schiene verdeckt und gibt dem System daher eine elegante Form. Das Schiebetürsystem bietet neben der Standardbremse, eine integrierte Anti-Shock Brems oder eine Softclose-Bremse an, durch die eine behutsame und kontrollierte Schließung der Tür ermöglicht wird. Das doppelte Softclose System ermöglicht die sanfte Schließung an beiden Enden der Schiebetür – auch bei einer minimalen Breite von 635mm.

Fluido 70 kann an der Decke, der Wand oder einer abgehängten Decke montiert werden. Für die Wandmontage ist das wichtigste Merkmal der Abstand zwischen der Wand und der Glasscheibe, der, je nach Anforderung, zwischen 16 bis 24 mm variieren kann. Das System ist in zwei Oberflächen erhältlich: EV 1 oder Niro ähnlich.

KOMPAKT

Fluido 70 ist ein kompaktes und elegantes System, bei dem sich der gesamte Mechanismus hinter dem Abdeckung der Schiene verbirgt und sich somit durch ein minimalistisches Design auszeichnet.

MINIMAL UND ELEGANT

Die Maße des Systems erlauben einen reduzierten Abstand zwischen Wand und Glasscheibe und zwischen dem Schiebeelement und dem festen Element.

VIELSEITIG

Fluido 70 passt sich durch seine Vielseitigkeit den Montageansprüchen ob an Wand, Decke oder abgehängter Decke an. Es kann auch an einem festen Element montiert werden. Erhältlich in verschiedenen Oberflächen. Wahlmöglichkeit zwischen Softclose- oder Antishock-Bremse.

REVERSIBEL

Es kann an der Wand von beiden Seiten montiert werden, indem man die vorgebohrten Befestigungslöcher verwendet. Dieses Merkmal, das im Bereich der Schiebetürsysteme einzigartig ist, erlaubt es, den Abstand zwischen Glas und Wand, je nach Einbausituation zu wählen.

SICHER UND FLIESSEND

Dank der Softclose-Technologie, ermöglicht das System eine sanfte Öffnung wie auch Schließung, ohne Rückstöße auf den letzten Zentimetern. Garantierte Sicherheit.

HANDLICH UND EINFACH

Fluido 70 ist leicht und schnell zu montiert, egal ob in gewerblichen oder privaten Bereichen. Das Profil ist vorgebohrt und ermöglicht somit eine schnelle Montage.



COLCOM GROUP SPA
Via Degli Artigiani 56
25075 Nave (Brescia) Italia
Tel. 030 2532008
Fax 030 2534707
info@colcomgroup.it

+ info saheco.com



saheco
sistemi per porte scorrevoli